

HOSPITAL BED ACCESSORIES

Head board and Foot board

HF-01



HF-02



HF-03

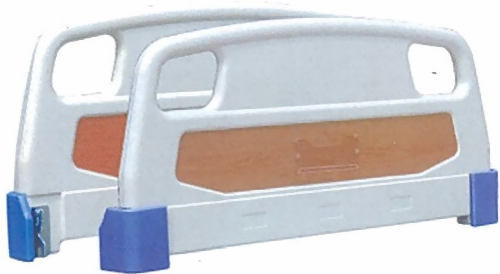

HF-04



HF-05



HF-06



HF-07



HF-08



HF-09A



HF-09B(with Protection wheel)



HF-10



HF-11



HF-12



HF-13



HF-14



HF-15



HF-16



HF-17



HF-18



HF-19



HF-20



HF-21



HF-22



HF-23



HF-24



HF-25



HF-26



HF-27



HF-27



HF-28

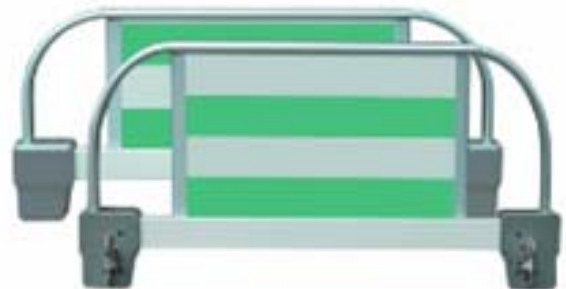

HF-29



HF-30



HF-31



HF-32



ABS/PP Bed side rails

BSR-01

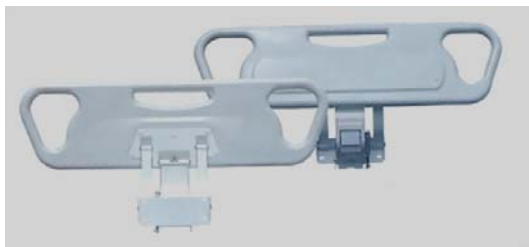

BSR-02



BSR-03

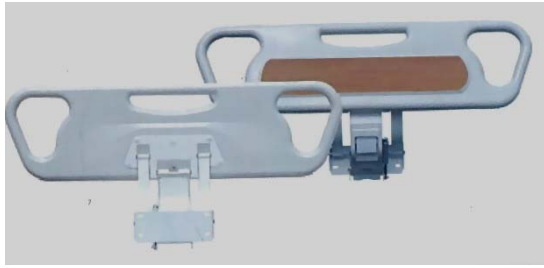

BSR-04

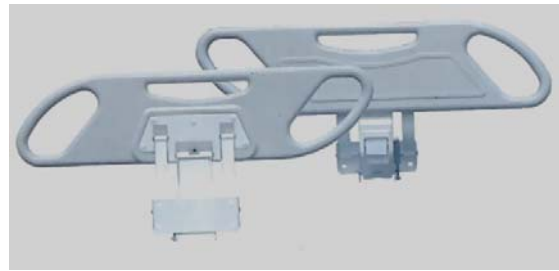

BSR-05



BSR-06

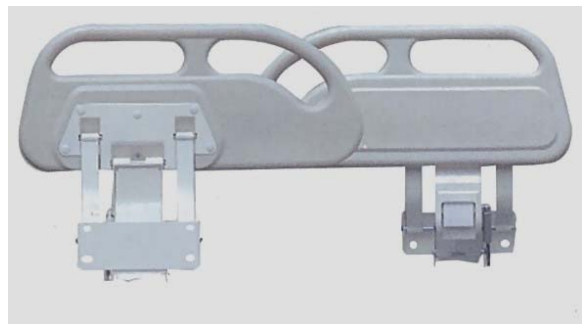

BSR-07



BSR-08



BSR-09



BSR-10



BSR-11



BSR-12

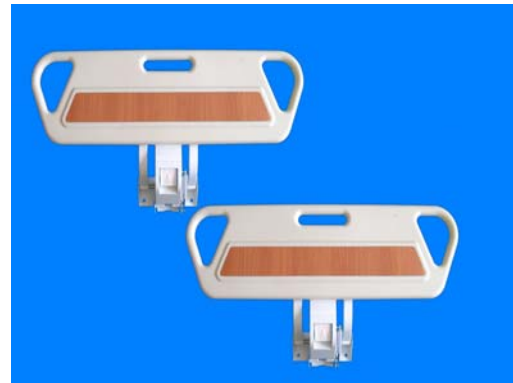

BSR-13



BSR-14



BSR-15



BSR-16

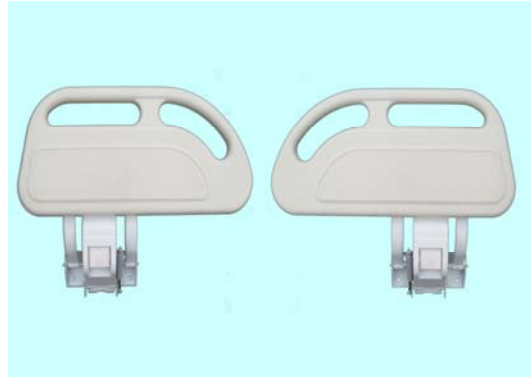

BSR-17

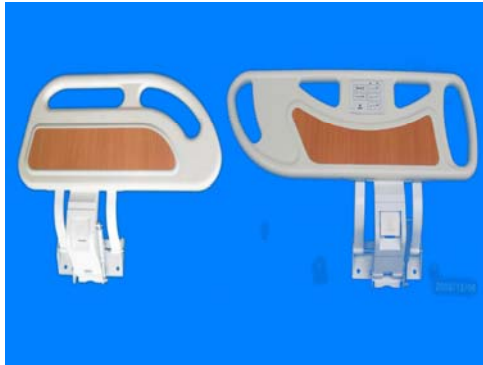

BSR-18



BSR-19



BSR-20



BSR-21

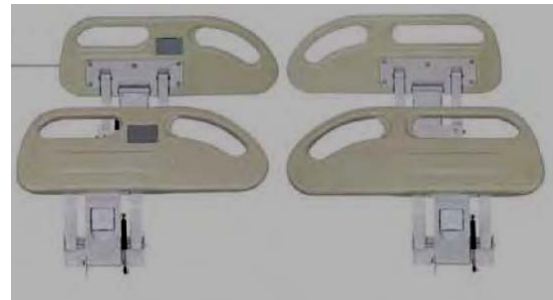

BSR-22



BSR-23



Aluminum alloy bed side rail

AABSR-01

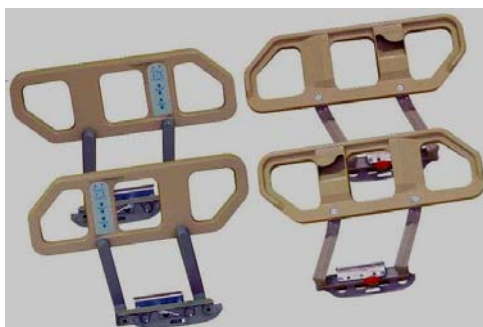

AABSR-02

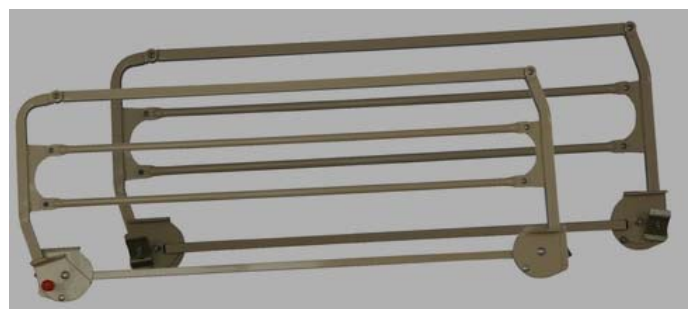

AABSR-03



AABSR-04

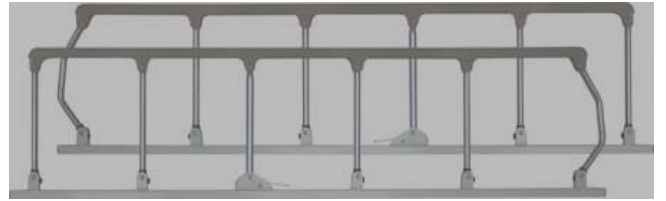

AABSR-05

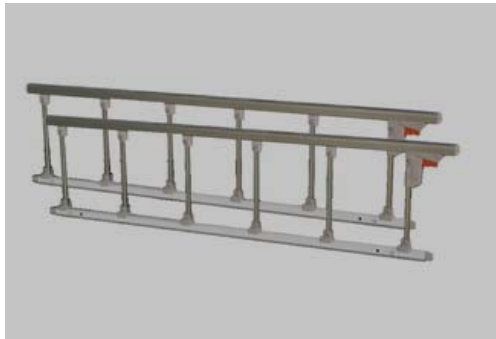

AABSR-06

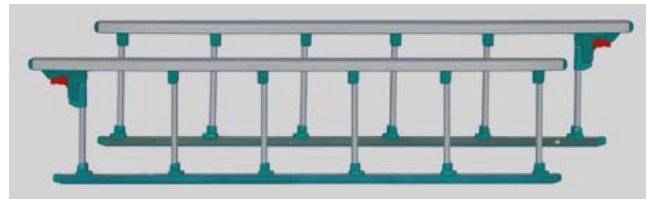

AABSR-07



AABSR-08

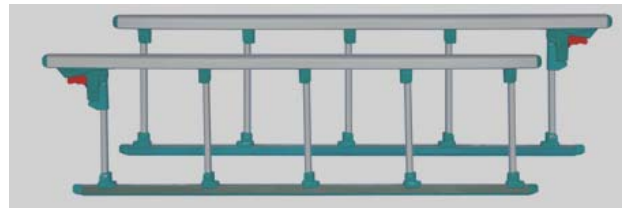

AABSR-09



AABSR-10

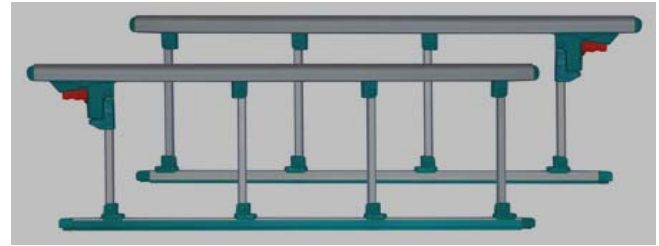

AABSR-11



AABSR-12



AABSR-13



AABSR-14



AABSR-15

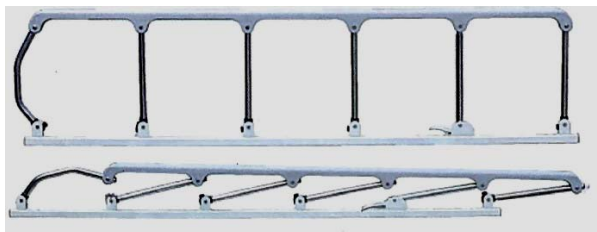

AABSR-16





Hospital bed rocker

HBR-01

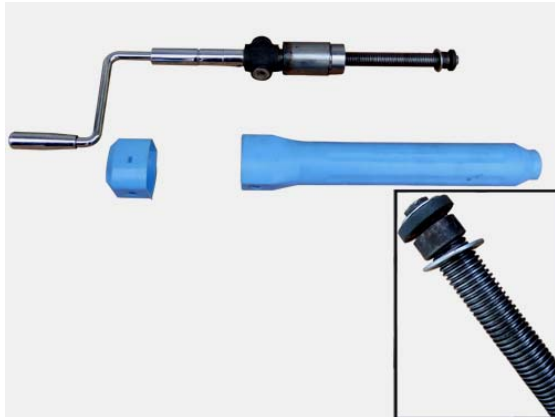

HBR-02

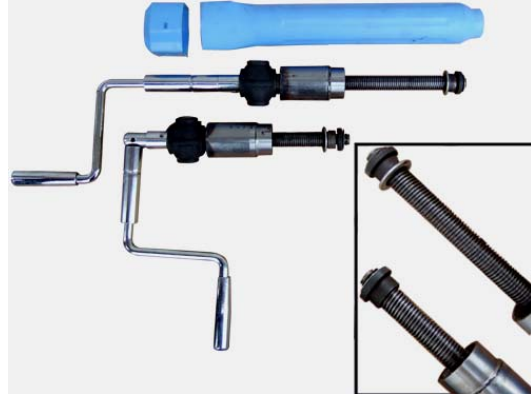

HBR-03

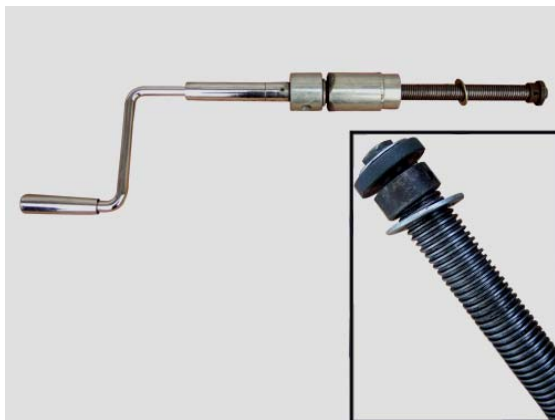

HBR-04

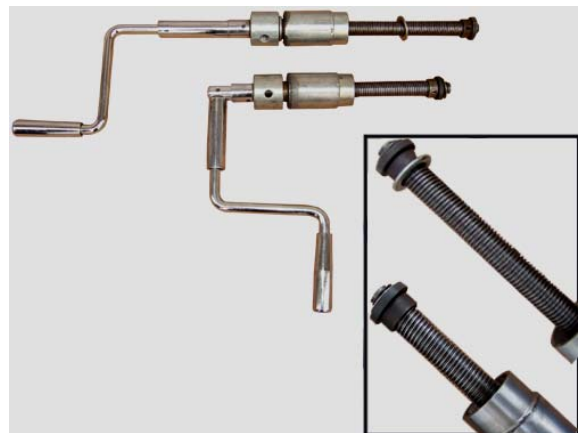

HBR-05



HBR-06



HBR-07

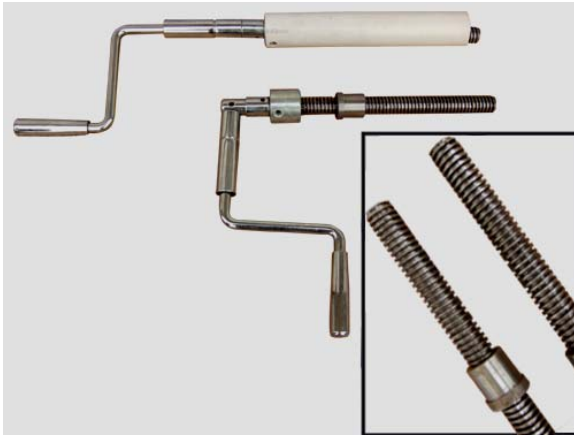

HBR-08



HBR-09

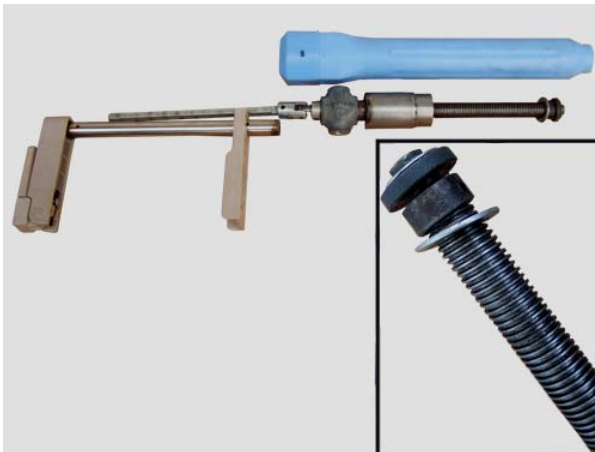

HBR-10



HBR-11

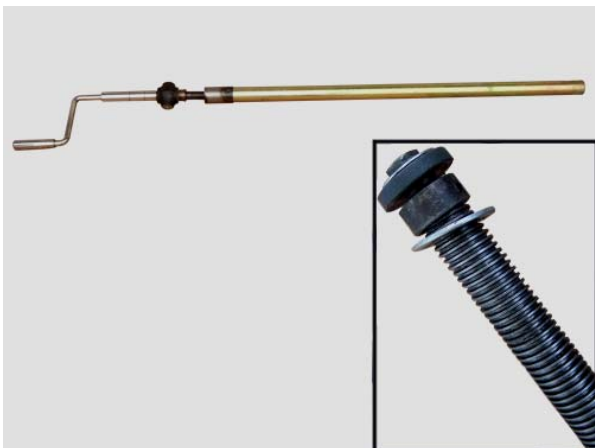

HBR-12



HBR-13



HBR-14

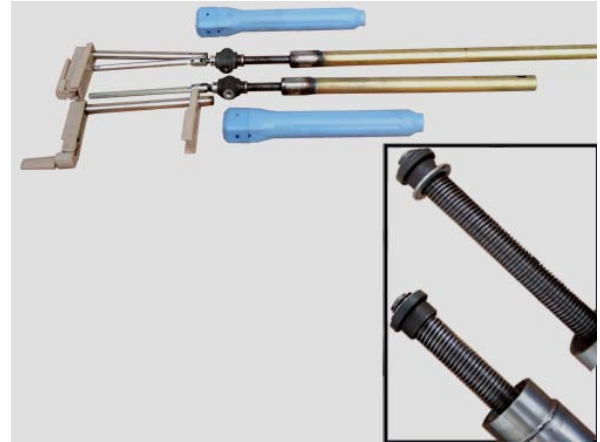

Hospital bed board

HBB-01

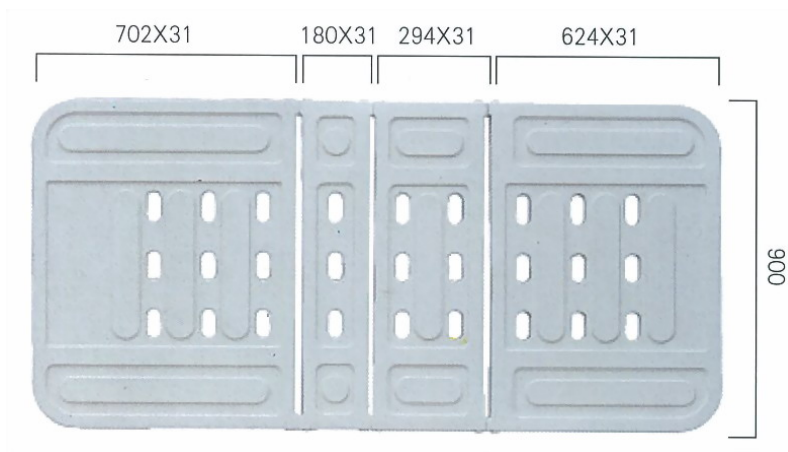

HBB-02



HBB-03



HBB-04



HBB-05

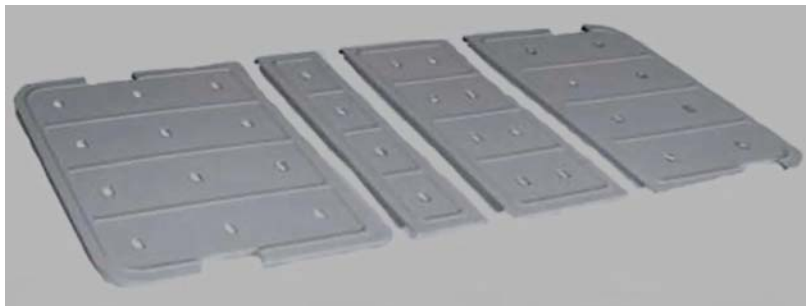

Other Hospital beds Accessories

Aluminum alloy soft connection r bed board



Bed board connection Accessory

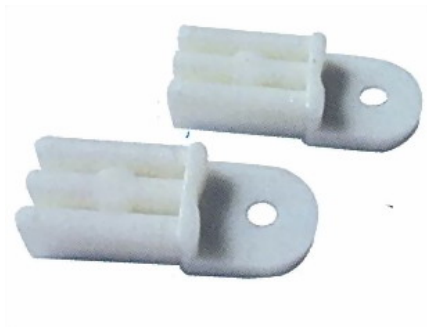

Bedside corner wrapping



Bed Protective bumpers



Bedside hook Type A



Bedside hook Type B



Bedside hook Type C



Chassis

Type A



Type B

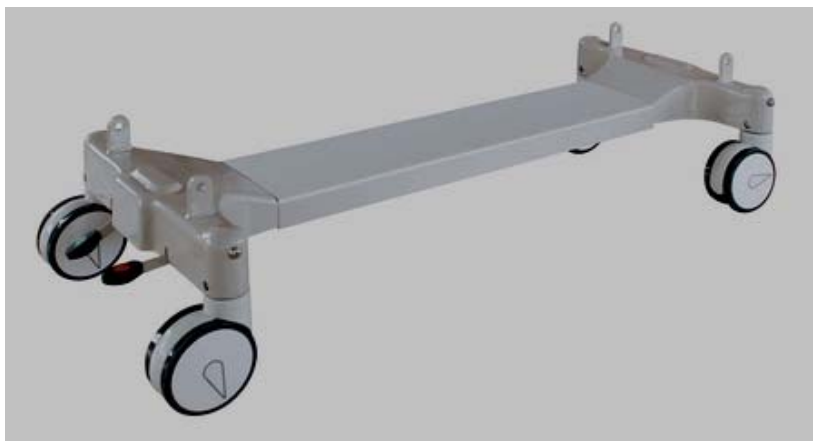

Dinning table board

DAB-01



DAB-02



DAB-03

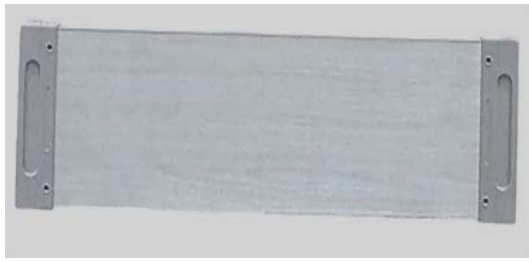

DAB-04



DAB-05



DAB-06

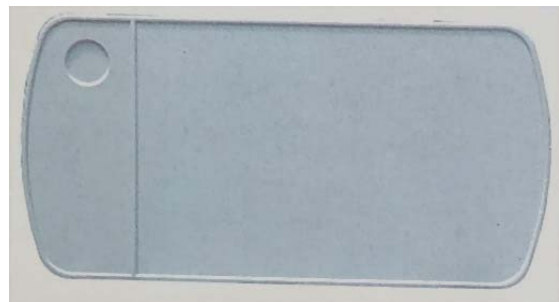
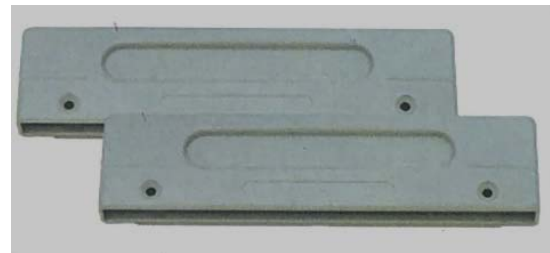

Table accessories



Table joint



Surface for cabinet Type A



Surface for cabinet Type B



Hand rail for the accompany chair



IV pole



Connection part

A Plastic B Aluminum

